

Product	CCT (K)	Light source of energy efficiency class	Driver	Options	kg
WL140V LED12S	3000/4000	D/E	PSU	ELB3	2,4
		E	PSR	ELB3 MDU	2,5
		E	PSED	ELB3	2,0/2,5
WL140V LED20S		E	PSU	ELB3	2,4
		E	PSR	ELB3 MDU	2,55
		E	PSED	ELB3	2,0/2,5
WL140V LED34S		E	WIA	ELB3	2,0/2,5
		D	PSU	ELB3	2,45
		D	PSR	ELB3 MDU	2,6
	D	PSED	ELB3	2,05/2,55	
		D	WIA	ELB3	2,05/2,55

220V 50Hz
240V 60Hz

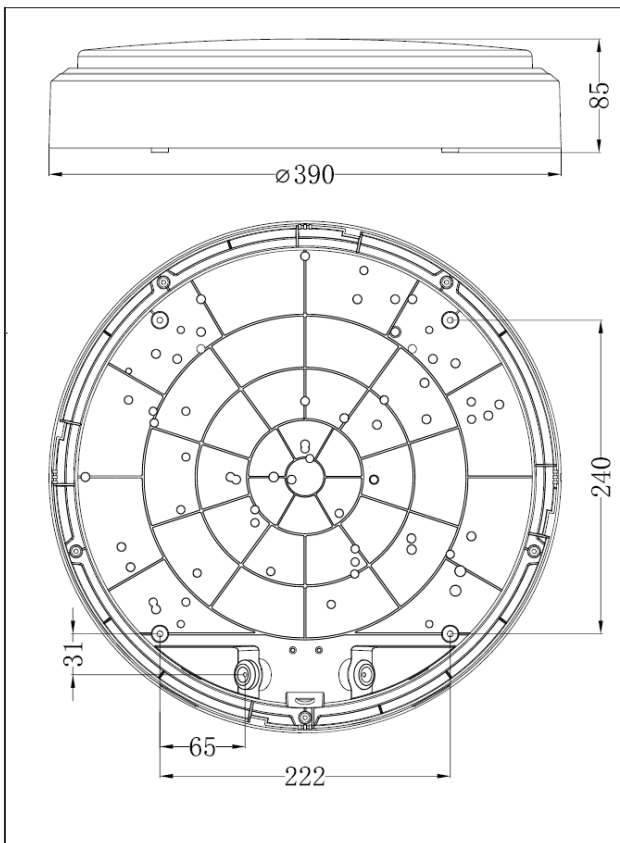

- The luminaire shall be installed by a qualified electrician and wired in accordance with the latest IEE electrical regulations or the national requirements .
- The light source contained in this luminaire shall only be replaced by the manufacturer or his service agent or a similar qualified person .
- For use in environments where an accumulation of conductive dust on the luminaire may be expected .
- For outdoor operation at a building: only when all its cables run indoor with a maximum distance of 10 meter .

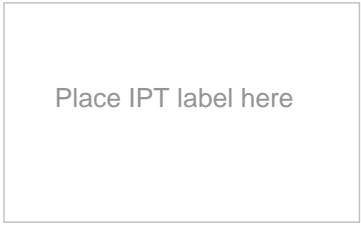
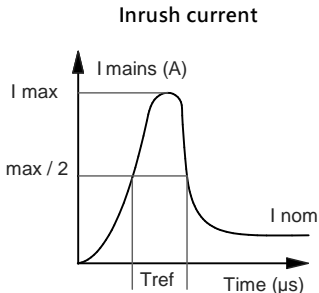
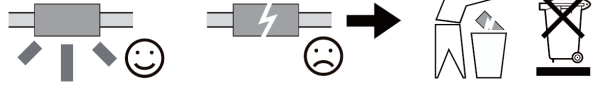

	Electrical characteristics			
	LED12S/20S/34S			LED20S/34S
	PSU ELB3	PSR ELB3	PSED/ELB3	WIA/ELB3
I_{max} (A)	14	10	18	4,9
T_{ref} (µs)	7	66	250	56
MCB	Luminaires Max. (pcs)			
B-10A	20	25	21	15
B-13A	25	32	27	19
B-16A	32	42	34	24
C-10A	33	42	35	24
C-13A	43	58	45	32
C-16A	54	65	57	40



583 - 444316025571
2021-08-06
© Signify Holding
All rights reserved

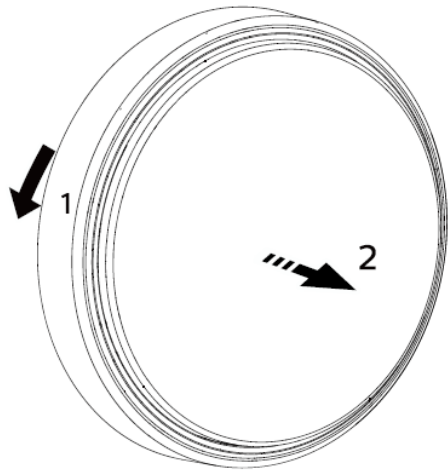
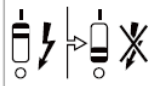

1

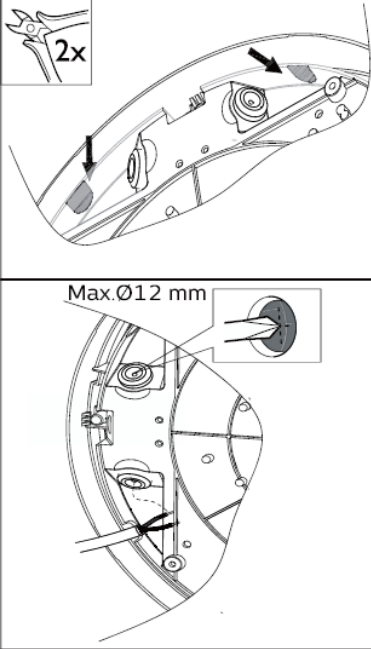

2

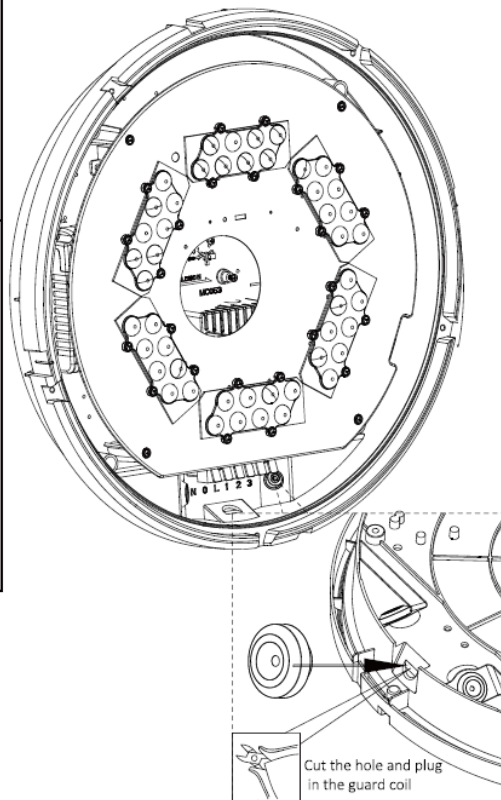

Cut the hole and plug in the guard coil

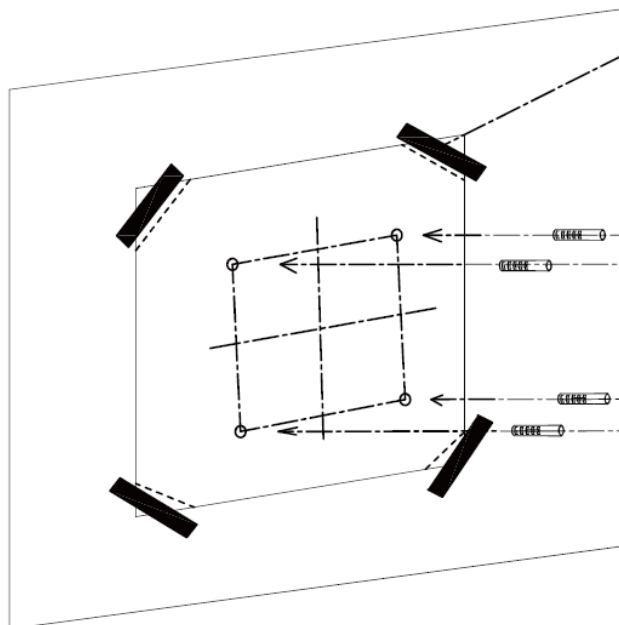

Fixed board

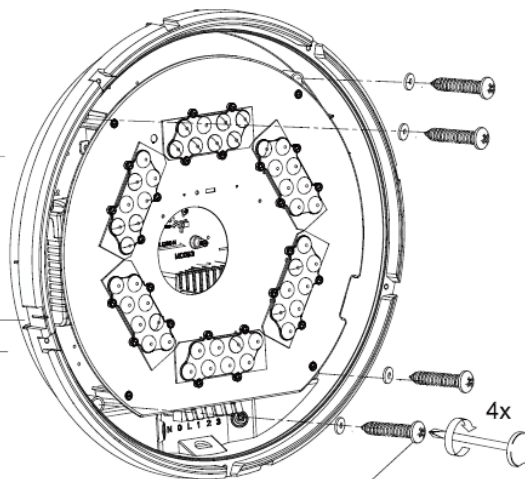
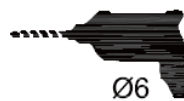

4x ST3.9x25

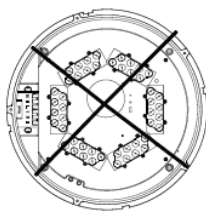

3

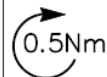
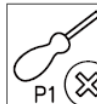

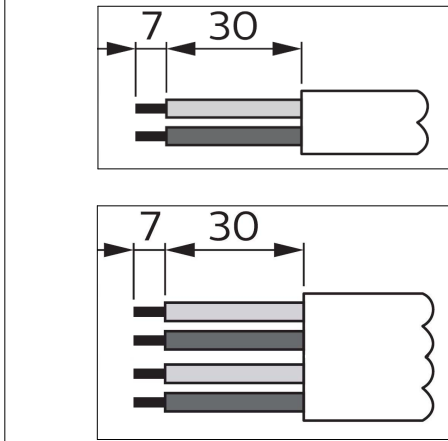
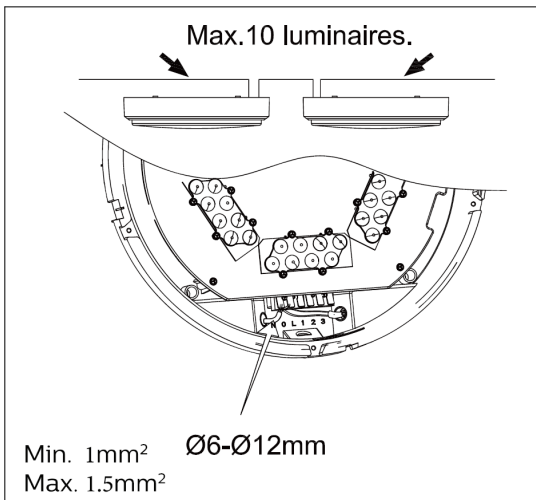

4

Type	N	0	L	1	2	3
PSU ELB3	N		L			L' = Switched L
PSR MDU	N		L	1-10V+	1-10V-	
PSR ELB3 MDU	N		L			L' = Switched L
PSED	N		L	DA/LS	DA/N	
PSED ELB3	N		L	DA/LS	DA/N	L' = Switched L
WIA	N		L			
WIA ELB3	N		L			L' = Switched L

5

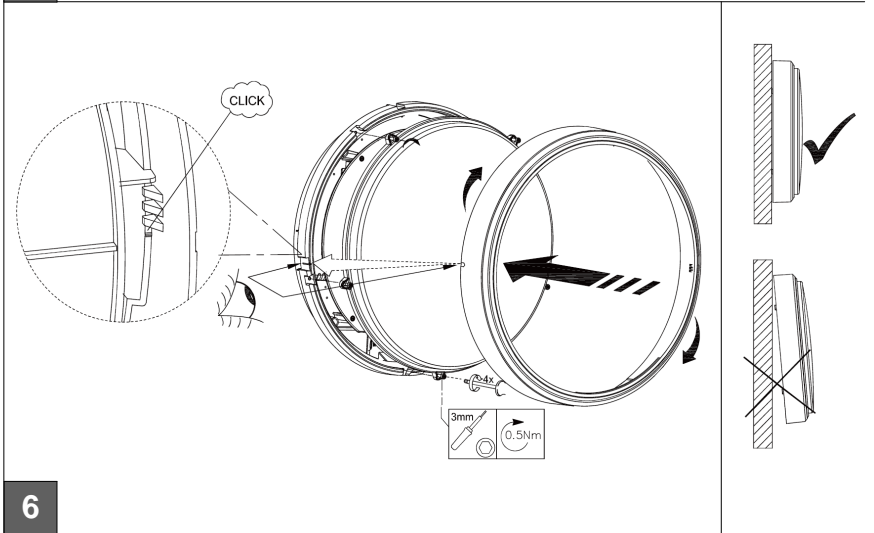

6

Emergency Luminaires with Batteries

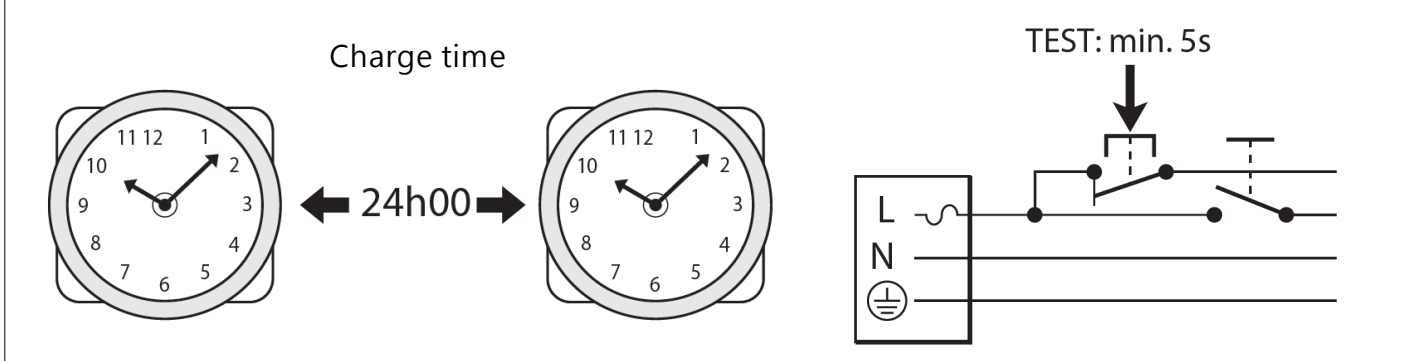

Lifetime
The batteries have a life time expectancy of 4 years when maintained properly. Replace after that time!

Periodic testing
Periodic tests should be performed according to EN50172: 2004, clause 7.2.3 and 7.2.4.
Each month the driver is running in emergency mode for 30 seconds. Once a year a full discharge cycle should be performed. The tests could be done by complete disconnection of the luminaire.

Light intensity distribution curves in emergency mode

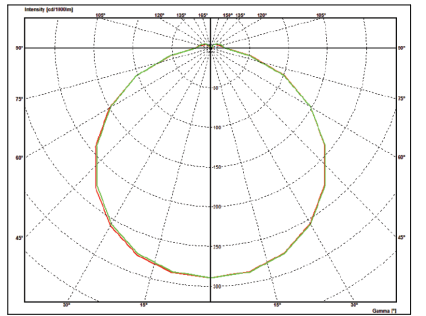



Replacement Battery

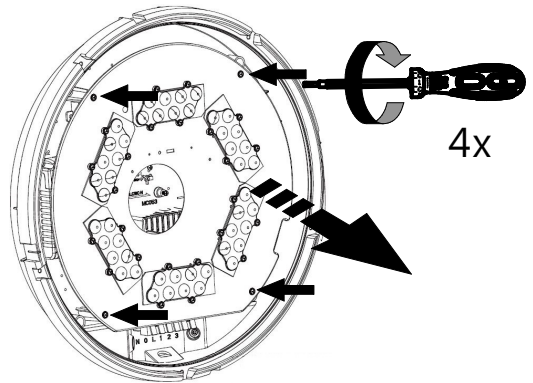
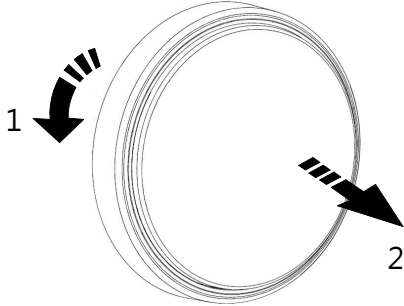

1

2

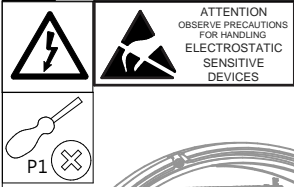

ATTENTION
OBSERVE PRECAUTIONS
FOR HANDLING
ELECTROSTATIC
SENSITIVE
DEVICES

Disconnect Battery

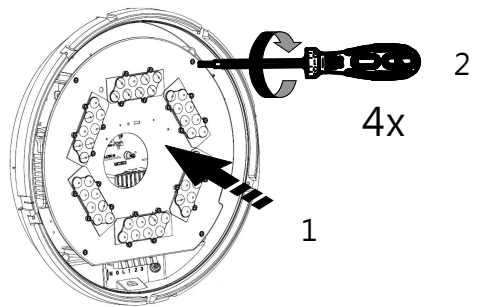
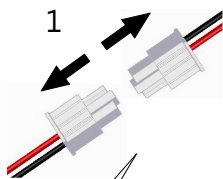

Replace Battery

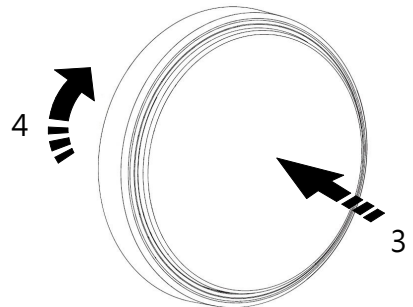

3

4

Functional Notice for Emergency Lighting Automatic emergency time selection

After installation and power up the driver will detect the battery and start the automatic detection process.

- During automatic detection, the indicator LED will light up with short green flashes.
- Between minimum 6 and maximum 30 seconds the TrustSight driver will set the battery type (number of cells) and will set the emergency output power accordingly.

After that, the system is defined and fully operational. The battery type definition has influence on the performance during the self-test and on the battery charge method. When the automatic battery detection process is disrupted, e.g. by switching off the permanent mains, the detection process is stopped and the TrustSight emergency driver will go into emergency mode with the lowest output power. At a next power up, the automatic detection process will start again.

Periodic testing

Periodic tests of emergency lighting luminaires must be performed according to EN50172 clause 7.2.3 and 7.2.4. Switch on in the emergency mode each month by simulation of a failure of the supply to the normal lighting for a period sufficient to ensure that each lamp is illuminated. Twice per year, each luminaire shall be tested for its full rated duration (at least 3hrs).

For more information please consult the TrustSight Gen 3 Design in guide. The latest version is available online

Emergency unit						
Manufacturer	Unit	Power	Duration	Number of cells	Nominal voltage	Luminous flux
Philips	TrustSight BASIC 15-55V LFP	3 W	3 h	4	6,4 V	350 lm

Motion Detection Unit (MDU) for PSR HF (High Frequency) Motion Sensor

By selecting the combination on the DIP switch, sensor data can be precisely set for each specific application.

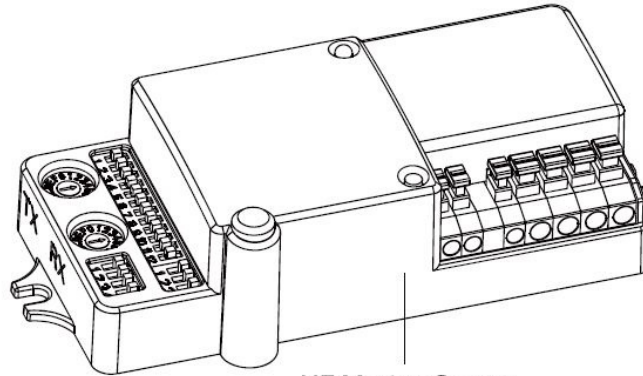

HF Motion Sensor

Function

Singlesensor function

1. Switch on/off (Stand-by period at "0s")



① With sufficient ambient light, the light will not be switched on even if with motion signal .



② With insufficient ambient light, the sensor switches on the light when motion is detected.



③ After elapse of hold time, the sensor switches off the light when no motion is detected.

2. Step dimming (stand-by period at "+∞")

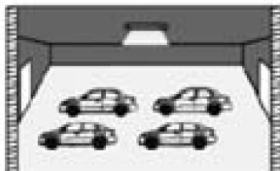

① If there is no motion detected, the light will be remained at a low light level all the time.

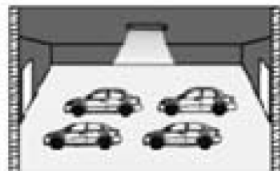

② When motion is detected, the sensor will switch on the light to 100% brightness.

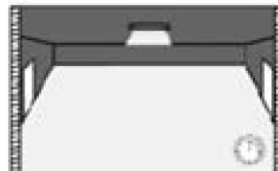

③ After elapse of hold time, the sensor dims the light at the present low light level if no motion is detected.

3. Step dimming (stand-by period at "1min/3min/10min/30min") .

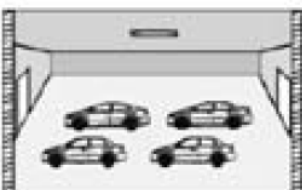

① With sufficient ambient light, the light will not be switched on even if with motion signal.

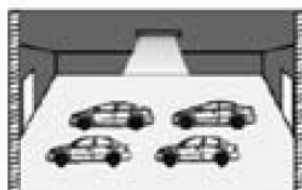

② With insufficient ambient light, the sensor switches on the light when motion is detected.

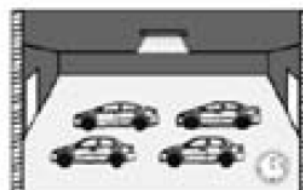

③ After elapse of hold time, the sensor dims the light at a low light level if no new motion is detected.



④ After elapse of standby period, the sensor switches off the light if no motion is detected in the detection zone.

more info for motion sensor: www.merrytek.com

1



Scan me!



2

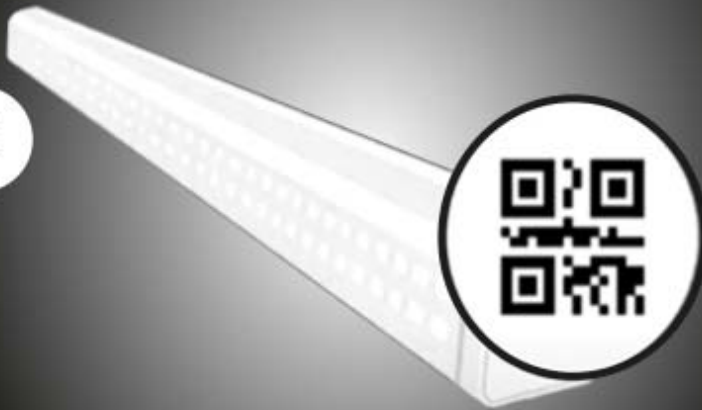

Register me!

SCAN



To get an overview of all spare parts for a luminaire, please refer to detailed instructions in the service manual available via the Signify Service tag apps (Android and iOS).



LED indicator status

LED indicator (colour / flashing)	Error condition	Cause	Solution
Green / no		System OK, battery fully charged	
no indication		mains off, EM mode, Rest mode, test in progress	
Green / slow		System OK, battery is charging	
Green / fast		System OK, recently tested (< 5 days, Australia mode only)	
RED / no	Battery voltage too high or too low	No battery connected	Connect a battery
		Wrong or bad battery connected	Replace battery
RED / fast	Output voltage too low or too high	Wrong LED load connected	Connect a right load and perform functional test
	no load connected or output shorted	Wrong connection	Connect a right load and perform functional test
RED / slow	Failed test due to battery	Battery end of life	Replace battery and perform a duration test.
		Charger failure	replace driver
RED -Green/ fast		DALI identify device	

Fast flashing: f = 2 Hz (on-time = 250 ms, off-time = 250 ms)
 Slow flashing: f = 0.66 Hz (on-time = 250 ms, off-time = 1250 ms)



GB - Disconnect before servicing FR - Mettre hors tension avant intervention DE - Öffnen nur spannungsfrei NL - Stroom afsluiten voor onderhoud LT - Pirms apkopes atvienojiet no elektrības EE - Katkesta elektrii toide enne valgusti hooldustremontii PT - Desconecte antes de fazer a manutenção	DK - Frakobl, før service NO - Koble fra før service FI - Irrota pistoke ennen huolto CZ - Před servisem se odpojíte TR - Servis yapmadan önce bağılantıyı kesin HR - Prije servisiranja isključite GR - Αποσυνδέστε πριν από τη συντήρηση BG - Изключете преди сервис RU - Отключите перед обслуживанием LV - Pirms apkopes atvienojiet to	IT - Togliere tensione prima di fare manutenzione ES - Desconectar antes de manipular SE - Bryt strömmen före lampbyte SK - Odpojit' pred údržbou SI - Pred servisiranjem izključite svetilko HU - Karbantartás előtt húzza ki a csatlakozót PL - Odłącz przed serwisowaniem RO - Deconectați-vă înainte de întreținere
--	--	--

GB	Luminaire has basic insulation between Low Voltage supply and control conductors.	SE	Armaturen har enkelisolering mellan lågvoltförsörjningen och styrledningarna.	GR	Το φωτιστικό διαθέτει βασική μόνωση μεταξύ της χαμηλής τάσης τροφοδοσίας και των αγωγών ελέγχου.
ES	La luminaria tiene un aislamiento básico entre la alimentación de baja tensión y los cables de la señal de control.	NO	Armaturet har enkelisolering mellom lavvoltforsyningen og styrledningene.	CZ	Ve svítidle je mezi vodiči napájení a řízení základní izolace.
PT	A luminária tem um isolamento básico entre a alimentação de baixa tensão e os cabos de sinal de controlo.	FI	Valaisimessa on peruseristys syöttöjännitteen ja ohjausohjelmien välillä.	TR	Armatur, Alçak Gerilim beslemesi ile kontrol iletkenleri arasında temel izolasyona sahiptir
DE	Die Leuchte verfügt über eine einfachen Isolation zwischen der Niederspannungsversorgung und den Steuerleitungen .	HU	A lámpatest kieszűltésű és szabályozó bemeneti galvanikusan el vannak választva.	SK	Svietidlo má základnú izoláciu medzi vodičmi zdroja nízkeho napätia a riadiacimi vodičmi.
FR	Le luminaire comporte une isolation de base entre l'alimentation basse tension et les câbles de contrôle.	RO	Corpul de iluminat dispune de izolație de bază între sistemul de alimentare de joasă și conductorii de control.	LT	Šviestuvos turi elementarią izoliaciją tarp žemos įtampos maitinimo ir valdymo laidų.
IT	Il grado di isolamento tra il conduttore di alimentazione ed il conduttore di segnale è básico.	BG	Осветителното тяло има основна изолация между захранването ниско напрежение и контролните проводници.	LV	Gaismeklim ir pamata izolācija starp zemsprieguma barošanas un vadības aprīkojuma.
NL	Armatuur heeft een basisisolatie tussen laagspannings-voeding en controle bedrading.	RU	Светильник обладает базовой электроизоляцией между низковольтным блоком питания и управляющими проводниками.	EE	Valgustil on põhiisolatsioon madalpinge toite ja juhtimisseedmele vahel.
DK	Armaturet har enkelisolering mellem lavvoltforsyningen og styrledningerne.	PL	Oprawa posiada podstawową izolację pomiędzy modulem zasilania niskonapięciowego i przewodami sterującymi.	SI	Svetilka ima osnovno izolacijo med nizkonapetostnimi napajalnimi in regulacijskimi vodniki.
				HR	Svjetiljka ima osnovnu izolaciju između napajanja i upravljačkih konektora.
GB	The light source and/or control gear and/or the external flexible cable contained in this luminaire shall only be replaced by the manufacturer or his service agent or a similar qualified person.	RO	Sursa de lumină și / sau aparatul și / sau cablul flexibil extern conținut în acest aparat de iluminat trebuie înlocuite numai de producător sau de agentul său de service sau de o persoană calificată similară.		
ES	La fuente de luz/o el driver / o el cable flexible contenido en la luminaria solo podrá ser sustituido por el fabricante o su agente de servicio o por una persona cualificada.	FI	Tässä valaisimessa oleva valonlähde ja/tai muut komponentit, kuten liitäntälaitte ja/tai ulkoiset kaapelit saadaan vaihtaa vain valmistajan tai tämän valtuuttaman huoltoedustajan tai vastaavan pätevan henkilön toimesta.		
PT	A fonte de luz e/ou o equipamento de controlo e/ou o cabo externo flexível nesta luminária só devem ser substituídos pelo fabricante ou pelo seu agente de serviço ou por pessoa qualificada para tal.	TR	Bu armatürde bulunan ışık kaynağı ve / veya kontrol tertibatı ve / veya harici esnek kablo, yalnızca imalatçı veya onun servis temsilcisi veya benzer bir kalifiye kişi tarafından değiştirilmelidir.		
DE	Die in dieser Leuchte enthaltene Lichtquelle und/oder das Betriebsgerät und/oder das externe flexible Anschlusskable darf nur vom Hersteller oder seinem Kundendienst oder einer ähnlich qualifizierten Person ausgetauscht werden.	HR	Izvor svjetlosti / ili predspojna naprava / ili vanjski fleksibilni napojni kabel sadržan u ovoj svjetiljci smije zamijeniti samo proizvođač, ovlaštenu servisera ili adekvatna stručno osposobljena i ovlaštena osoba.		
FR	La source lumineuse et/ou le contrôleur de courant et/ou le câble souple d'alimentation contenus dans ce luminaire ne doivent être remplacés que par le fabriquant, un de ses agents ou une personne qualifiée.	GR	Η φωτεινή πηγή ή/και τα όργανο έναυσης/ελέγχου ή/και το εξωτερικό καλώδιο που περιέχεται στο εν λόγω φωτιστικό πρέπει να αντικαθίστανται μόνο από τον κατασκευαστή ή τον αντιπρόσωπο σέρβις ή παρόμοιο ειδικευμένο πρόσωπο.		
IT	La sorgente luminosa e/o il dispositivo di controllo e/o il cavo flessibile esterno contenuti in questo apparecchio di illuminazione sono sostituiti solo dal costruttore o dal suo agente di servizio o da una persona qualificata analoga.	BG	Източникът на светлина и / или пусково-регулируща апаратура и / или външният гъвкав кабел, съдържащ се в това осветително тяло, трябва да бъдат заменени само от производителя или неговия оторизиран сервиз или подобно квалифицирано лице.		
NL	De lichtbron en/of voorschakelapparatuur en/of de flexibele voedingskabel van dit armatuur mag alleen vervangen worden door de fabrikant of haar service dealer of een vergelijkbaar gekwalificeerd persoon.	RU	Источник света и / или ПРА и / или внешний гибкий кабель, содержащиеся в этом светильнике, могут быть заменены только производителем, его агентом по обслуживанию или аналогичным квалифицированным лицом.		
DK	Lyskilden og/eller driver og/eller eksterne kabler indeholdt i dette armatur må kun udskiftes af producenten eller godkendt service partner eller lignende kvalificeret person.	SK	Svetelný zdroj a/alebo predradník a/alebo externý flexibilný kabel obsiahnutý v tomto svietidle môže byť vymenený len výrobcom alebo servisným partnerom alebo inou podobne kvalifikovanou osobou.		
SE	Ljuskällan och/eller styrsystemet och/eller den externa kablerna i denna armatur får endast bytas ut av tillverkaren eller en kvalificerad person.	LT	Šviestos šaltinis ir/arba valdymo įrenginys ir/arba išorinis lankstus kabelis esantis šiame šviestuve gali būti pakeistas tik gamintojo arba jo aptarnavimo agento ar tai atitinkancio kvalifikuoto asmens.		
NO	Lyskilden og/eller driveren og/eller den eksterne kablerna i dette armaturet skal bare erstattes av produsenten eller dens service agent eller tilsvarende kvalifisert person.	LV	Gaismas avotu un / vai vadības ierīci un / vai ārējo elastīgo kabeli, kas atrodas šajā gaismeklī, drīkst nomainīt tikai ražotājs vai viņa servisa pārstāvis vai līdzīga kvalificēta persona.		
CZ	Světelný zdroj a/nebo napájecí zdroj (předradník) a/nebo flexibilní napájecí kabel v tomto svítidle smí být vyměňovat pouze výrobce nebo jeho servisní technik nebo obdobně kvalifikovaná osoba.	EE	Selles valgustis sisalduva valgusalikka ja/või juhtimisseedme ja/või välise painduva kaabli võib välja vahetada ainult tootja, vastav hooldusspetsialist või muu sarnane kvalifitseeritud isik.		
HU	A lámpatestben található fényforrást és/vagy működtető szerelvényt és/vagy a külső rugalmas kábelt csak a gyártó, a gyártóval szerződött cég vagy megfelelő képesítéssel rendelkező szakember cserélheti ki.	SI	Vir svetlobe in / ali napajalnik in / ali zunanji prilagodljivi kabel, ki ga vsebuje ta svetilka, lahko zamenja le proizvajalec ali njegov servis ali podobna usposobljena oseba.		
PL	Źródło światła i/lub zasilacz i/lub zewnętrzny przewód zasilający, który jest w sprawie powinien być wymieniony przez producenta lub jego serwisanta lub kwalifikowany personel.				

- GB Storage, installation, use, operation and maintenance of the products needs to be performed exactly according the instructions in this manual and/or other instructions as may be provided by us to guarantee safe use of the product over its entire lifetime. Failure to adhere to these instructions will invalidate your entitlement to warranty. Bolts with indication of torque strength on the drawing need to be tightened using a calibrated torque wrench. Pre-assembled bolts need to be retightened again to the required torque specification to assure maximum strength over lifetime.
- ES El almacenamiento, instalación, uso, funcionamiento y mantenimiento de este producto debe realizarse exactamente según las instrucciones de este manual, así como otras instrucciones que le proporcionemos con el fin de garantizar un uso seguro del producto durante toda su vida útil. Si no se cumplen estas instrucciones, la garantía quedará anulada. Los tornillos con indicación de par de apriete en el dibujo, deben apretarse con una llave dinamométrica calibrada. Los tornillos del acoplamiento premontados deben reapretarse de nuevo con la especificación de par de apriete necesaria para garantizar una solidez máxima durante toda la vida útil de la luminaria.
- PT Para garantir uma utilização segura do produto durante a respetiva vida útil, o armazenamento, a instalação, a utilização, a operação e a manutenção dos produtos tem de ser efetuados exatamente de acordo com as instruções neste manual e/ou com outras instruções que possam ser fornecidas por nós. O incumprimento destas instruções irá invalidar o direito a garantia. Os parafusos com indicação do torque no esquema tem de ser apertados utilizando uma chave dinamométrica calibrada. Os parafusos pré-montados tem de ser novamente apertados de acordo com a especificação de torque necessário para garantir uma resistência máxima durante a vida útil.
- DE Lagerung, Installation, Verwendung, Betrieb und Wartung der Produkte müssen genau nach den Anweisungen in dieser Anleitung und/oder anderen von uns zur Verfügung gestellten Anweisungen erfolgen, um eine sichere Verwendung des Produkts über seine gesamte Lebensdauer zu gewährleisten. Bei Nichtbeachtung dieser Hinweise erlischt Ihr Anspruch auf Gewährleistung. Schrauben mit Angabe der Drehmomente auf der Zeichnung müssen mit einem kalibrierten Drehmomentschlüssel angezogen werden. Vormontierte Schrauben müssen mit dem angegebenen Drehmoment nachgezogen werden, um eine maximale Festigkeit über die gesamte Lebensdauer zu gewährleisten.
- FR Le stockage, l'installation, l'utilisation et la maintenance des produits doivent être effectués conformément aux instructions de ce manuel et / ou d'autres instructions que nous fournissons afin de garantir une utilisation sûre du produit pendant toute sa durée de vie. Le non-respect de ces instructions invalidera votre droit à la garantie. Les vis, dont les couples de serrage sont indiqués sur les schémas, doivent être serrées à l'aide d'une clé dynamométrique étalonnée. Les vis préassemblées doivent être resserrées à nouveau selon la spécification de couple de serrage requis afin d'assurer leur résistance maximale pendant toute leur durée de vie.
- IT Le stock, l'installazione, l'uso, il funzionamento e la manutenzione dei prodotti devono essere eseguiti esattamente in base alle istruzioni contenute nel presente manuale e / o in altra documentazione fornita da noi per garantire la sicurezza del prodotto per l'intera durata del suo utilizzo. La mancata osservanza di queste istruzioni annullerà la garanzia. I bulloni, con indicazione sull'intensità della coppia serraggio sul disegno devono essere serrati utilizzando una chiave dinamometrica calibrata. I bulloni pre-assemblati devono essere riserrati nuovamente secondo le specifiche di coppia richieste per assicurare la massima resistenza per tutta la durata.
- NL Om een veilig gebruik van dit product gedurende zijn hele levensduur te garanderen, dient het opslaan, installeren, gebruiken, bedienen en onderhouden ervan exact te worden uitgevoerd in overeenstemming met de instructies in deze handleiding en/of andere door ons geleverde instructies. Niet opvolgen van deze instructies maakt uw garantieaanspraken ongeldig. Bouten waarvan in de tekening het aanhaalkoppel is vermeld, dienen te worden vastgezet met behulp van een momentsleutel. Voorgeassembleerde bouten dienen opnieuw te worden aangehaald tot het vereiste koppel om maximale strekte gedurende de hele levensduur te waarborgen.
- DK Opbevaring, installation, brug, betjening og vedligeholdelse af produkterne må kun udføres ifølge instruktionerne i denne vejledning og/eller eventuelle øvrige instruktioner fra Signify for at garantere sikker brug af produktet i hele dets levetid. Hvis disse instruktioner ikke følges, bortfalder produktgarantien. Bolte/skruer med angivet spændingsmoment på tegningen skal spændes med en indstillet momentnøgle. Færdigsamlede bolte/skruer skal efterspændes i henhold til det specificerede moment for at sikre maksimal fastgørelse i hele produktets levetid.
- SE Förvaring, installation, användning, drift och underhåll av produkterna måste utföras enligt instruktionerna i denna handbok och/eller andra instruktioner som kan tillhandahållas av oss för att garantera säker användning. Om instruktioner inte följs frångår man produktgarantin. Skruvar där vridmoment anges på ritningen måste dras åt med en kalibrerad skiftnyckel. Förmonterade skruvar måste dras åt igen med angivet vridmoment för att säkerställa högsta styrka under livslängden.
- NO Oppbevaring, montering, bruk, drift og vedlikehold av produktene må utføres nøyaktig i samsvar med instruksjonene i denne handboken og/eller andre instruksjoner vi måtte gi for å garantere sikker bruk av produktet i hele dets levetid. Hvis instruksjonene ikke følges, bortfaller garantien. Bolter med angivelse av dreiemoment på tegningen må strammes med en kalibrert momentnøkkel. Ferdigmonterte bolter må strammes på nytt til pakrevd dreiemoment for å sikre maksimal styrke i hele produktets levetid.
- FI Tuotteiden asennuksessa, käytössä ja huollossa on noudatettava tarkoin tässä käyttöoppaassa tai muissa toimittamissamme ohjemateriaaleissa annettuja ohjeita. Tämä varmistaa tuotteiden turvallisen toiminnan koko sen käyttöajan ajan. Näiden ohjeiden noudattamatta jättäminen mitätöi kaikki oikeutesi takuukorvauksiin. Pultit, joille on asennusohjeessa ilmoitettu tietty kiristystiukkuus, on kiristettävä kalibroidulla momenttiavaimella. Esiasennetut pultit on kiristettävä ilmoitettuun kiristystiukkuuteen koko käyttöajan mittaisen kestävyuden varmistamiseksi.
- HU A terméknek tárolását, telepítését, használatát, üzemeltetését és karbantartását pontosan a jelen kézikönyvben és / vagy az általunk biztosított egyéb utasításoknak megfelelően kell elvégezni, hogy garantáljuk a termék biztonságos használatát az élettartama alatt. Ezen utasítások be nem tartása érvényteleníti a jótállási jogát. A rajzon a nyomaték-erősséggel jelzett csavarokat meg kell húzni egy kalibrált nyomatékkulccsal. Az előre összeszerelt csavarokat újra meg kell húzni a szükséges nyomaték specifikációhoz, hogy biztosítsák a maximális szilárdságot az élettartam során.
- PL Przechowywanie, instalacja, użytkowanie, obsługa i konserwacja produktów musi odbywać się ściśle według wytycznych zawartych w niniejszej instrukcji i / lub w innych instrukcjach, które dołączamy aby zagwarantować bezpieczne użytkowanie produktu przez cały okres eksploatacji. Nieprzestrzeganie tych instrukcji może spowodować utratę prawa do gwarancji. Śruby, przedstawione na rysunku wskazującym siłę momentu dokręcania, muszą być dokręcone za pomocą kalibrowanego klucza dynamometrycznego. Aby zapewnić maksymalną wytrzymałość w całym okresie użytkowania, wstępnie zamontowane śruby należy dokręcić zgodnie z wymaganą specyfikacją momentu dokręcania.
- RO Depozitarea, instalarea, utilizarea, operarea și întreținerea produselor trebuie să fie efectuate exact în conformitate cu instrucțiunile din acest manual și/sau cu alte instrucțiuni care pot fi furnizate de noi pentru a garanta utilizarea în siguranță a produsului, pe întreaga durată de viașă a acestuia. Nerespectarea acestor instrucțiuni vă va anula dreptul la garanție. Șuruburile care au cuplul de strângere indicat pe desen, trebuie să fie strânse cu ajutorul unei chei dinamometrice calibrate. Șuruburile preasamblate trebuie să fie strânse din nou la specificația de cuplu cerută, pentru a asigura rezistența maximă pe întreaga durată de viașă.
- CZ Při uchování, montáži, používání a údržbě produktů je třeba postupovat přesně podle pokynů v této příručce a dalších našich případných pokynů, které zajišťují bezpečné používání produktů po celou dobu jejich životnosti. Když tyto pokyny dodržovat nebudete, přijdete o záruku. Šrouby, které mají na výkresu uveden utahovací moment, je třeba utahovat zkalibrovaným momentovým klíčem. Předem namontované šrouby je třeba dotáhnout požadovaným momentem, aby po dobu životnosti produktu držely na místě.

TR	Ürünlerin saklanması, kurulumu, kullanımı, çalıştırılması ve bakımı, ürünün kullanım ömrü boyunca güvenli kullanımının sağlanması amacıyla tam olarak bu kılavuzdaki ve / veya tarafımızdan sağlanan diğer talimatlara uygun biçimde gerçekleştirilmelidir. Söz konusu talimatlara uyulmaması, ürünle ilgili garanti hakkınızı geçersiz kılar. Teknik çizimde yanında sikkma torku değeri belirtilen civatalar kalibre edilmiş bir tork anahtarı kullanılarak sıkılmalıdır. Önceden takılmış olarak gelen civataların da belirtilen tork değerine uygun biçimde yeniden sıkılması, kullanım ömrü boyunca maksimum dayanıklılığın sağlanması açısından önemlidir.		
BG	Съхранението, инсталирането, употребата, експлоатацията и поддръжката на продуктите трябва да се извършват точно в съответствие с указанията в това ръководство и / или други инструкции, които могат да бъдат предоставени от нас, за да се гарантира безопасна употреба на продукта през целия му експлоатационен живот. Неспазването на тези указания ще обезсили Ващото право на гаранция. Болтовете с индикация за силата на въртящия момент на чертежа трябва да бъдат затегнати с помощта на калибриран гаечен ключ. Предварително сглобените болтове трябва да бъдат отново затегнати до изискваната спецификация на въртящия момент, за да осигурят максимална якост по време на експлоатационния живот.		
GR	Η αποθήκευση, η εγκατάσταση, η χρήση, η λειτουργία και η συντήρηση των προϊόντων πρέπει να γίνεται ακριβώς σύμφωνα με τις οδηγίες του παρόντος εγχειριδίου ή / και τις άλλες οδηγίες που ενδεχομένως να παρασχεθούν, προκειμένου να είναι εγγυημένη η ασφαλής χρήση του προϊόντος για ολόκληρη τη διάρκεια ζωής του. Η μη εφαρμογή αυτών των οδηγιών θα ακυρώσει τα δικαιώματά σας στο πλαίσιο της εγγύησης. Οι βίδες με ένδειξη τιμής ροπής σύσφιξης στο σχέδιο θα πρέπει να σφίχθούν με τη χρήση ενός βαθμονομημένου ροπακλειδού. Οι προ-συναρμολογημένες βίδες πρέπει να σφίχθούν και πάλι με την απαιτούμενη τιμή ροπής σύσφιξης, προκειμένου να διασφαλιστεί η μέγιστη ισχύς σε όλη τη διάρκεια ζωής.		
RU	Чтобы гарантировать безопасное использование этого изделия на протяжении всего соответствующего срока службы, его хранение, установку, использование, эксплуатацию и обслуживание необходимо осуществлять в точном соответствии с приведенными в настоящем руководстве инструкциями и (или) иным инструкциями, которые могут быть предоставлены нами. Несоблюдение этих инструкций приведет к потере прав на гарантию. Болты, для которых на чертеже указан крутящий момент, необходимо затягивать калиброванным динамометрическим ключом. Для обеспечения максимальной прочности изделия в течение всего срока службы болты, завинченные в ходе предварительной сборки, необходимо подтянуть до указанного момента.		
SK	Uskladnenie, inštalácia, používanie a údržba produktov je potrebné postupovať presne podľa pokynov v manuáli a/alebo iných nami poskytnutých pokynov, ktoré zaisťujú bezpečné používanie produktu počas celej doby životnosti. Nedodržaním týchto pokynov sa ruší záruka. Skrutky s naznačenou silou utiahnutia, musia byť utiahované kalibrovaným momentovým kľúčom. Vopred namontované skrutky musia byť znovu utiahnuté podľa požadovanej špecifikácie, aby komponenty držali na mieste počas celej životnosti.		
HR	Pohranjivanje, instaliranje, uporaba, korištenje i održavanje proizvoda treba se vršiti točno u skladu s uputama u ovom priručniku i/ili s drugim uputama osiguranim s naše strane kako bi se jamčila sigurna uporaba proizvoda kroz cijeli radni vijek. Nepoštivanje ovih uputa poništava vaše pravo na jamstvo. Vijci s indiciranim momentom zatezanja na nacrtu trebaju biti učvršćeni korištenjem zateznog alata s kalibriranim momentom zatezanja. Također i već učvršćeni vijci trebaju biti dotezani do specificiranog zateznog momenta kako bi se osigurala učvršćenost tijekom cijelog radnog vijeka.		
LT	Produktų saugojimas, montavimas, naudojimas, eksploatavimas ir priežiūra turi būti atlikti tiksliai pagal instrukcijas, pateiktas šiame vadove ir (arba) kitas instrukcijas, kurias mes galime pateikti, kad garantuotume saugų gaminio naudojimą per visą jo eksploatavimo laiką. Jei nesilaikysite šių instrukcijų nurodymų bei reikalavimų, jūs teisė į garantiją bus panaikinta ir nebegalios. Varžtai, nurodantys sukimo momento stiprumą brėžinyje, turi būti užveržti naudojant kalibruotą sukimo momento veržliaraktį. Iš anksto sumontuotos varžtus reikia vėl priveržti iki reikiamo sukimo momento, kad būtų užtikrintas maksimalus tvirtumas per visą eksploatavimo laiką.		
LV	Izstrādājumu uzglabāšana, uzstādīšana, lietošana un apkope jāveic precīzi saskaņā ar šajā rokasgrāmatā sniegtajām instrukcijām un / vai citām instrukcijām, kuras mēs varam piedāvāt, lai garantētu produkta drošu lietošanu visā tā darbības laikā. Neievērojot šos norādījumus, jūsu tiesības uz garantiju tiek anulētas. Bullskrūves ar norādi uz griezes stiprumu zīmējumos jābūt pieskrūvētām izmantojot kalibrētu griezes atslēgu. Iepriekš samontētās skrūves ir atkal jāpievelk līdz vajadzīgajai griezes specifikācijai, lai nodrošinātu maksimālu pieguli visā ekspluatācijas laikā.		
EE	Toodete ladustamine, paigaldamine, kasutamine, käitamine ja hooldus tuleb läbi viia täpselt vastavalt selle juhendi juhistele ja/või muudele meie poolt pakutavatele juhistele, et tagada toote ohutu kasutamine kogu selle toote eluaja jooksul. Nende juhiste mittejärgimine kaotab teie õiguse garantiile. Poldid, millel on joonisel toodud pöördemomendi tugevus, tuleb pingutada kalibreeritud pöördemoment multriivõlme abil. Eelnevalt kinnitatud poldid tuleb uuesti pingutada vastavalt nõutavale pöördemomendi spetsifikatsioonile, et tagada maksimaalne kinnituse tugevus kogu eluea jooksul.		
SI	Skladiščenje, namestitve, uporaba, delovanje in vzdrževanje izdelkov mora biti natančno izvedeno v skladu z navodili v tem priločniku in / ali drugimi navodili za zagotovitev varne uporabe izdelka skozi celotno življenjsko dobo. V primeru neupoštevanja teh navodil, se lahko razveljavi pravica do garancije. Vijake, ki imajo označen navor, je potrebno zategniti s kalibriranim navornim ključem. Vijake, ki so že sestavljeni, je potrebno znova priviti v skladu z zahtevanim navorom, da je zagotovljena maksimalna moč skozi življenjsko dobo.		
GB	This product contains a light source of energy efficiency class: see table or label.	RO	Acest produs contine o sursă de lumină cu clasa de eficiență energetică: a se vedea tabelul sau eticheta.
ES	Este producto contiene una fuente luminosa de la clase de eficiencia energética: ver tabla o etiqueta.	CZ	Tento výrobek obsahuje světelný zdroj s třídou energetické účinnosti: viz tabulka nebo štítek.
PT	Este produto contém uma fonte de luz da classe de eficiência energética: ver tabela ou rótulo.	FI	Tämä tuote sisältää valonlähteen, jonka energiatehokkuusluokka on: katso taulukko tai etiketti.
DE	Dieses Produkt enthält eine Lichtquelle der Energieeffizienzklasse: siehe Tabelle oder Etikett.	SE	This Denna produkt innehåller en ljuskälla med energieffektivitetsklass: se tabell eller etikett.
FR	Ce produit conti nt une source lumineuse de classe d'efficacité énergétique: voir tableau ou étiquette.	HU	Ez a termék egy energiatékonysági osztályú fényforrást tartalmaz: lásd a táblázatot vagy a címkét.
IT	Questo prodotto contiene una sorgente luminosa di classe di efficienza energetica: vedere tabella o etichetta.	SK	Tento výrobok obsahuje svetelný zdroj triedy energetickej účinnosti: pozri tabuľku alebo štítok.
NL	Dit product bevat een lichtbron van energie-efficiëntieklasse: zie tabel of label.	HR	Ovaj proizvod sadržiava izvor svjetlosti klase enemetske učinkovitosti: vidi tablicu ili naljepnicu.
DK	Denne produkt indeholder en lyskilde i energieffektivitetsklasse: se table eller etiket.	LV	Šis ražojums satur gaismas avotu, kura energoefektivitātes klase ir: skatīt tabulu vai etiķeti.
LT	Šiame gaminyje yra šviesos šaltinis, kurio energijos vartojimo efektyvumo klasė: žr. lentelę arba etiketę.	EE	Toode sisaldab energiatõhususe klassi valgusallikat: vt tabelit või etiketti.
GR	Το προϊόν αυτό περιέχει φωτεινή πηγή της τάξης ενεργειακής απόδοσης: βλέπε πίνακα ή ετικέτα.	BG	Този продукт включва светлинен източник с клас на енергийна ефективност: вижте таблицата или етикета.
PL	Ten produkt zawiera źródło światła o klasie efektywności energetycznej: patrz tabela lub etykieta.	SI	Ta izdelek vsebuje svetlobni vir razreda energijske učinkovitosti: glej tabelo ali nalepko.

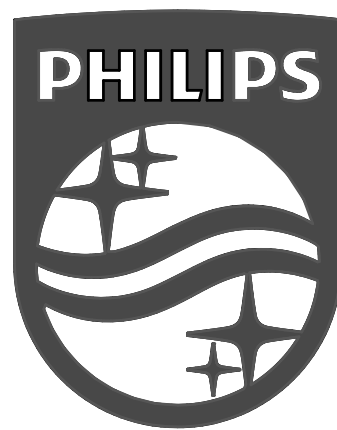

© 2021 Signify Holding

All rights reserved. Reproduction in whole or in part is prohibited without the prior written consent of the copyright owner. The information presented in this document does not form part of any quotation or contract, is believed to be accurate and reliable and may be changed without notice. No liability will be accepted by the publisher for any consequence of its use. Publication thereof does not convey nor imply any license under patent- or other industrial or intellectual property rights.

Signify Holding
The Netherlands